

Verifi™

BED BUG DETECTOR

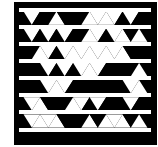

For step-by-step video instruction, scan this tag using the Microft Tag Reader app on your smartphone.

Contents:

1. Pitfall
2. Verifi Lure
3. Verifi Core
4. Security Holes
5. Verifi CO₂ Booster Pack
6. Harborage
7. Adhesive Backing
8. Verifi Holster
9. Zip Tie
10. CO₂ Pull Tab
11. Lure Activation Tool

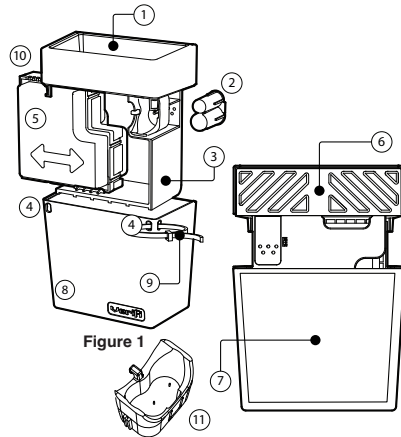

Activation:

1. Identify location for placement of Verifi™ Bed Bug Detectors. Place Verifi Bed Bug Detectors in a vertical position near suspected bed bug activity. For help identifying these locations visit our website at www.fmcprosolutions.com
2. Follow all handling and safety instructions contained in the Material Safety Data Sheet (MSDS).
3. Remove Verifi Core, Verifi Holster, Verifi Lure, and Verifi CO₂ Booster Pack from the packaging.
4. **Activation of the Verifi CO₂ Booster Pack:** [Figures 2, 3, 4, 5, 6]
 - a. Appropriate gloves and eye protection must be worn when handling the Verifi CO₂ Booster Pack.
 - b. Place Verifi CO₂ Booster Pack on a flat stable surface.
 - c. Carefully remove the foil seal from the Verifi CO₂ Booster Pack to expose the powder contents. Avoid contact with powder contents. [Figure 2]
 - d. Close the empty lid of the Verifi CO₂ Booster Pack [Figure 3], press firmly until closure snaps
 - e. Shake the sealed Verifi CO₂ Booster Pack vigorously for 5 seconds. [Figure 4]
 - f. Remove the red tab on the Verifi CO₂ Booster Pack to expose the vent. [Figure 5]
 - g. Slide the sealed Verifi CO₂ Booster Pack into the core. [Figure 6]

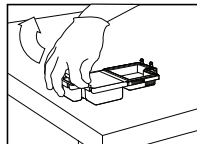

Figure 2

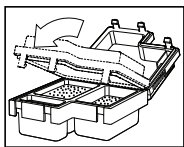

Figure 3

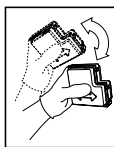

Figure 4

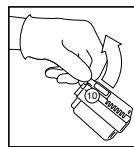

Figure 5

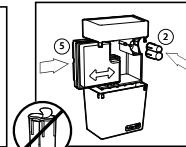

Figure 6

5. **Activation of Verifi Lure: DO NOT REMOVE THE FOIL FROM THE VERIFI LURE CAPSULE.** Remove a Verifi lure from the packaging and place it foil side up on a table. Remove the Verifi lure activation tool from the packaging and carefully place the activation tool over the Verifi lure. Be sure to fit the larger section of the lure activation tool over the larger section of the capsule. Press down, so that the tool pierces the foil. [Figure 7] Remove the tool from the lure capsule and there will be two small holes in the top of the foil. [Figure 8] Insert the Verifi Lure completely into slots in the Verifi Core with the foil facing the Verifi Core and the larger part of the Verifi Lure on the bottom. [Figure 9] The pins inside the lure activation tool may be sharp, do not place your finger inside tool.

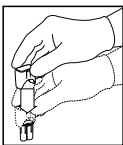

Figure 7

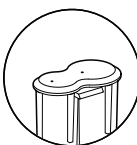

Figure 8

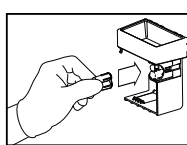

Figure 9

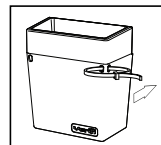

Figure 10

6. Slide the Verifi Core into the Verifi Holster with the Verifi CO₂ Booster Pack and Verifi Lure facing the front of the Verifi Holster. [Figure 6] Be sure that the Verifi Core completely snaps into the Verifi Holster.
7. Secure the Verifi Bed Bug Detector with a zip tie to prevent exposure or access to the internal components. [Figure 10]

Installation/Placement: Place the Verifi Bed Bug Detector vertically so the top of the detector is level, in a location where it cannot be moved. For hard surfaces, remove the

Precautions: Verifi CO₂ Booster Pack contains citric acid: contents can cause severe eye irritation, and skin and respiratory irritation. Avoid contact with eyes, skin or breathing dust particles. Contents may be harmful if swallowed. Verifi Lure contains n-Nonane: Flammable liquid and vapor. Harmful if inhaled. Causes skin and eye irritation. Avoid contact with skin or eyes or breathing vapor.*

FIRST AID	
IF INHALED	<ul style="list-style-type: none"> • Move person to fresh air. • If person is not breathing, call 911 or an ambulance, then give artificial respiration, preferably by mouth-to-mouth, if possible. • Call a poison control center or doctor for further treatment advice
IF ON SKIN OR CLOTHING	<ul style="list-style-type: none"> • Take off contaminated clothing. • Rinse skin immediately with plenty of water for 15-20 minutes. • Call a poison control center or doctor for treatment advice.
IF IN EYES	<ul style="list-style-type: none"> • Hold eye open and rinse slowly and gently with water for 15-20 minutes. • Remove contact lenses, if present, after the first 5 minutes, then continue rinsing eye. • Call a poison control center or doctor for treatment advice.
IF SWALLOWED	<ul style="list-style-type: none"> • Call a poison control center or doctor immediately for treatment advice. • Have person sip a glass of water if able to swallow. • Do not induce vomiting unless told to do so by the poison control center or doctor. • Do not give anything by mouth to an unconscious person.
<p>HOTLINE NUMBER: Have the product container or label with you when calling a poison control center or doctor, or going for treatment. You may also contact 1-800-331-3148 for emergency medical treatment information. For Information Regarding the Use of this Product Call 1-800-321-1FMC (1362)</p>	

*When used as directed, does not expose persons to harmful levels of vapors.

plastic backing covering the adhesive on the Verifi Holster and affix the Verifi Holster to the hard surface mounting target, ideally mounted in contact with or closely adjacent to the area where bed bugs are expected to be (i.e., mattress, box spring, etc.). **Note: The adhesive may cause damage to paint and drywall when the detector is removed. The detector should not be placed near open flames or heat sources.**

Cleaning: The Verifi Bed Bug Detector is intended for on-going bed bug monitoring. Verifi Bed Bug Detectors may contain live bed bugs after use, which should be collected and properly disposed of. Spraying all pieces of the Verifi Bed Bug Detector with CB-40*** is recommended when bed bugs are found. Wipe the pitfall and harborage area of the Verifi Core with a clean cloth. Once the Verifi Core has been cleaned, the Verifi Bed Bug Detector can be re-activated using a new Verifi CO₂ Booster Pack and Verifi Lure following the instructions above.

Replacement: For ongoing monitoring, the Verifi CO₂ Booster Pack and Verifi Lure should be replaced at least every 90 days.

Follow the instructions above to replace these components of the Verifi Bed Bug Detector.

Disposal: When monitoring is completed, enclose all components in a plastic bag and dispose of properly. Verifi Bed Bug Detectors may contain live bed bugs after use, which should be collected and properly disposed of. Spraying all pieces of the Verifi Bed Bug Detector with CB-40* is recommended prior to disposal.

Storage: Store detectors in cool dry place away from open flames and heat sources. Store separately to avoid contamination.

Limitation of Liability and Damages:

FMC Corporation believes that the information and recommendations contained herein are accurate as of the date hereof. The information provided herein relates only to the specific product designated and may not be applicable where such product is used in combination with any other materials or in any process. Further, since the conditions and methods of use are beyond the control of FMC Corporation, FMC Corporation expressly disclaims any and all liability as to any results obtained or arising from any use of the product or reliance on such information. **NO WARRANTY OF FITNESS FOR ANY PARTICULAR PURPOSE, WARRANTY OF MERCHANTABILITY, OR ANY OTHER WARRANTY, EXPRESSED OR IMPLIED, IS MADE WITH RESPECT TO THE SELECTION, PURCHASE, OR USE OF THIS PRODUCT OR THE INFORMATION PROVIDED HEREIN. THE EXCLUSIVE REMEDY OF THE USER OR BUYER, AND THE EXCLUSIVE LIABILITY OF FMC AND SELLER FOR ANY AND ALL CLAIMS, LOSSES, INJURIES OR DAMAGES (INCLUDING CLAIMS BASED ON BREACH OF WARRANTY, CONTRACT, NEGLIGENCE, TORT, STRICT LIABILITY OR OTHERWISE) RESULTING FROM THE USE OR HANDLING OF THIS PRODUCT, SHALL BE THE RETURN OF THE PURCHASE PRICE OF THE PRODUCT OR, AT THE ELECTION OF FMC OR SELLER, THE REPLACEMENT OF THE PRODUCT.**

This Conditions of Sale and Limitation of Warranty and Liability may not be amended by any oral or written agreement.

© 2011 FMC Corporation. All Rights Reserved. Patents pending. Verifi is a trademark of FMC.

**Use only where CB-40* is registered.

Verifi is intended for the detection of bed bugs only and does not prevent, destroy, repel, or mitigate bed bugs or any other pest.

FMC

FMC Corporation
Agricultural Products Group
1735 Market Street
Philadelphia, PA 19103